

Gunstock MagTube

ForceTube Setup EN

You laid your hands on one of our MagTube rifle, with MK1 classic stock or MK2 adjustable stock, or the ForceTube rifle, with haptic recoil stock.







For both, you will use the same following steps to build your gunstock. The images represent an MK1 classic stock, but this is the same for an MK2 adjustable stock or ForceTube haptic stock.









🕒 Mounting your MagTube / ForceTube gunstock should take 45m.

For video setup, [you can check our YouTube Playlists](#).

Make sure you work in a clear area and be very careful, some parts can easily be lost.



PARTS LIST

Bag N°1					
					
x1	x2	x1	x2	x1	x1
Sling ring	Connection with internal notches	20mm screw	O'ring	Nut	Notched Washer









Bag N°2							
							
x2	x1	x1	x1	1x	1x	x4	x2

Connection with external notches	T-notched connection	Hex screw	Butterfly	Hex washer	20mm screw	O'ring	Nut
----------------------------------	----------------------	-----------	-----------	------------	------------	--------	-----

Bag N°3								
								
x1	x1	x1	x2	x2	x2	x2	x1	x2
Ring Wedge	Connection with internal notches	T-notched connection	Hex screw	Butterfly	O'ring	Nut	Rubber washer	Hex washer

Tool bag	
	
x1	x1
0,4cm Hex Key	0,25cm Hex Key

MagTube - Rest of the Box

								
x1	x1	x1	x1	x1	x2	x1	x1	x1
Set of 3 tubes (13, 20 & 25 cm) (Chrome or Carbon)			Sling (1 or 2 points)	Pair of controller mounts	Magnetic retainer	Static stock (MK1 or MK2)	Bipod (Optional)	Pair of ProStraps (Optional)

ForceTube - Rest of the Box



STEP 1: GUNSTOCK

You will need: bag n°1, the smaller tube and rifle stock.

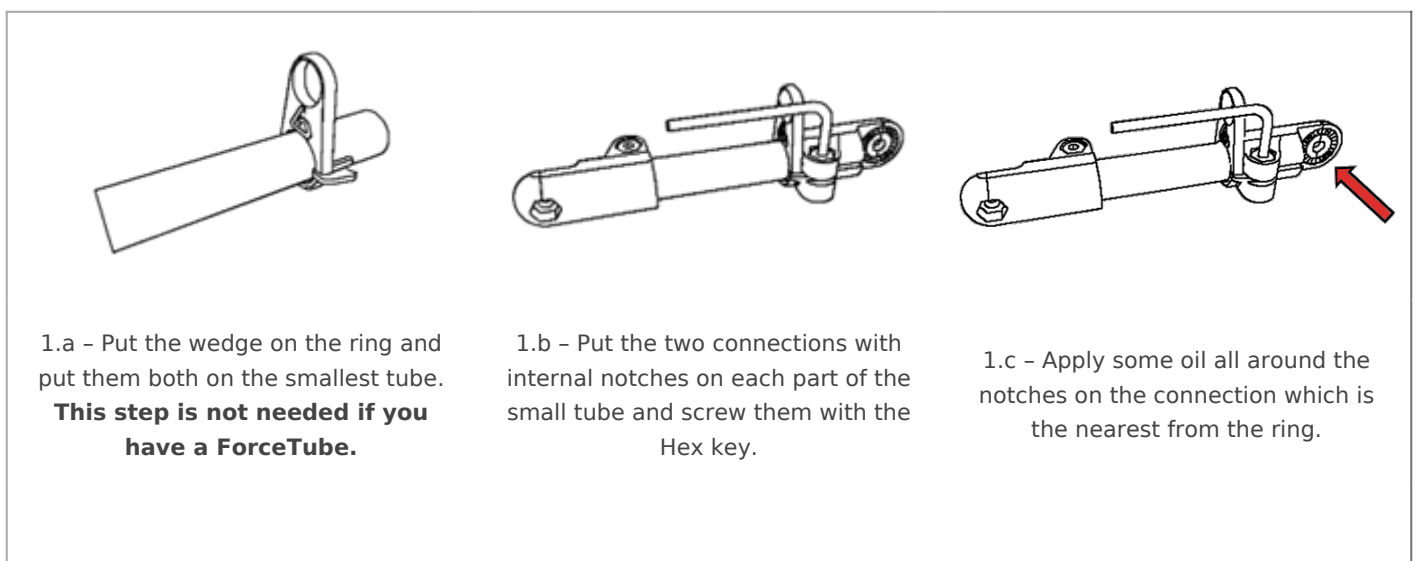



1.d - Put one O'ring on the 20mm screw, slot them both into the hole provided in the stock.

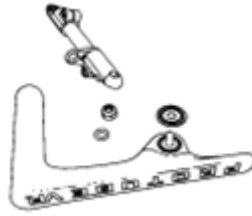

1.e - Then slide the notched washer (the notches have to be facing the same way) and the previously oiled connection over the screw.

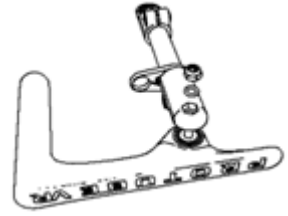

1.f - Attach the screw securing the stock and the connection with one O'ring and the nut.

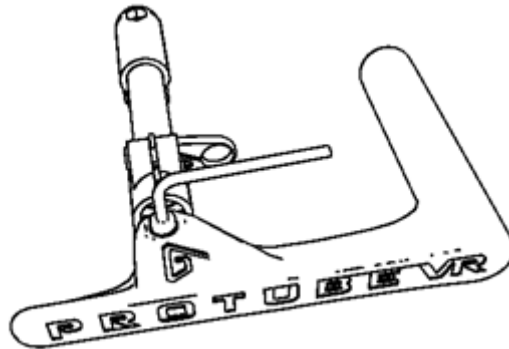

1.g - Screw all the pieces together, taking care not to over tighten. You must be still able to rotate the stock by force.

In the next steps, you will need the magnetic supports.
They are usually magnetically attached to the cups.
The magnets are quite strong when trying to detach them with hands, but do not be afraid of breaking them, they are made to resist this step.
You just need a little force to separate them.

https://www.protubevr.com/img/cms/Content_Support/Retrait
To help, here is a [.gif that shows how to separate them.](#)

STEP 2: REAR SIDE

You will need: bag n°2, medium tube and notched magnetic bracket.

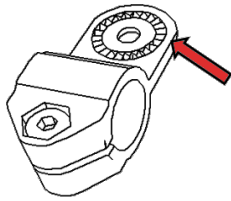

2.a - Apply some oil all around the notches on the T-notched connection. *The mag support is usually attached to the MagCup.*



2.b - Put one O'ring on the 20mm screw, slot them both into the hole provided in the notched magnetic bracket.



2.c - Then slide the previously oiled T-notched connection over the screw



2.d - Put one O'ring on the 20mm screw, slot them both into the hole provided in the stock.

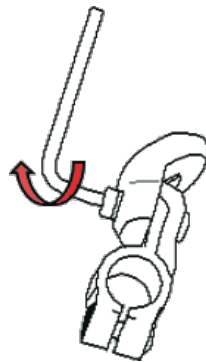

2.e - Screw all the pieces together, taking care not to over tighten. You must be still able to rotate the two parts by force.

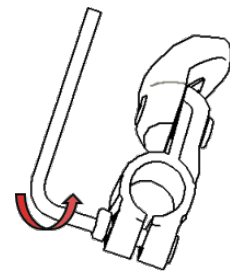

2.f - Unscrew the 18mm screw at the base of the T-notched connection. You will need it at the step 2.I).

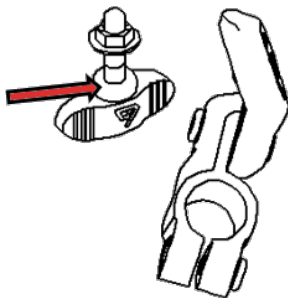

2.g - Set the butterfly screw on the hex washer. (note to Tao: the arrow is a separate image)

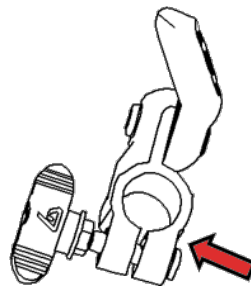

2.h - Screw the butterfly with the Hex screw to a nut on the other side

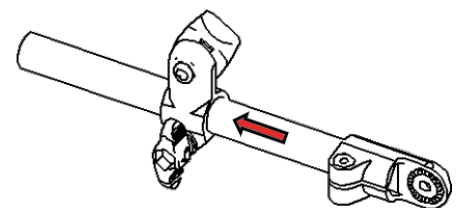

2.i - Slide the medium tube into the T-notched connection.

- If you aim with the right eye, the magnet must be facing right side.
- If you aim with the left eye, the magnet must be facing left side.

Then place the external notched connections on both side of the tube.

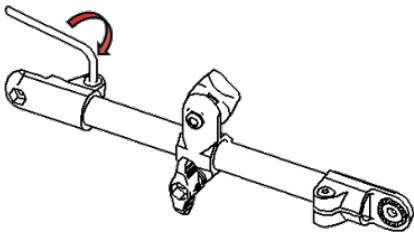

2.j - Finally screw the two external notched connections on the tube.

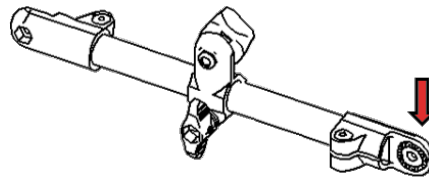

2.k - Apply some oil all around the external notches of the rear side.

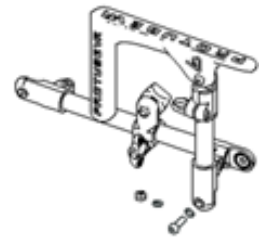

2.l - Place one O'ring on the 18mm screw (the one from 2.f). Slide them both through the internal notched connection and the external connection.

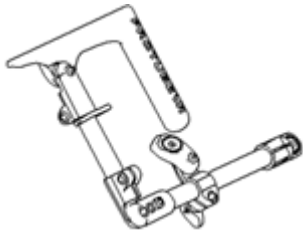

2.m - Attach the screw securing both connection with one O'ring and the nut.

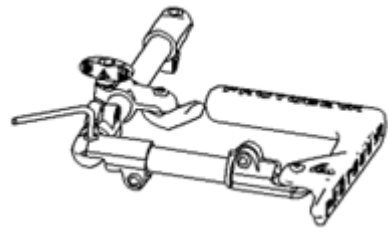

2.n - Screw all the pieces together taking care not to over tighten. You must be still able to rotate the two parts using force.

STEP 3: FRONT SIDE

You will need: bag n°3M, longer tube and smooth magnetic bracket.

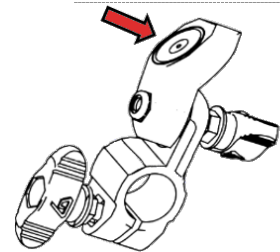
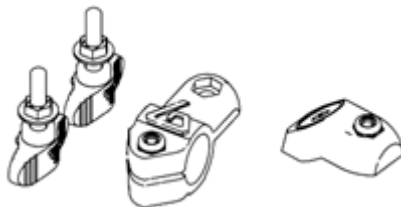
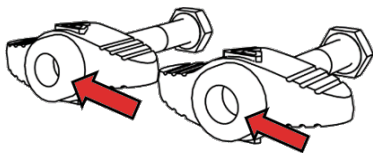

The mag retainer is usually attached to the MagCup (cf. intro of instruction)

3.a - Apply a dot of oil on the base of the butterflies part and attach each butterfly with one Hex screw.

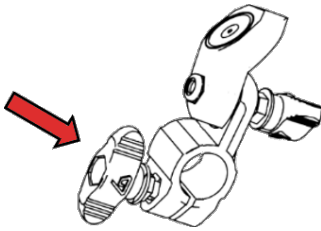

3.b - Remove the 18mm screw on the T-notched connection. You will need it at step 3.j.

Put the hex washers on the butterfly screws.

Put one nut on the T-notched connection and one on the smooth magnetic bracket.

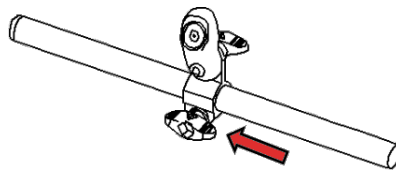

3.c - Slot one butterfly screw into the hole provided on top of the T-notched connection.

Then slot into the rubber washer.

Then slot into the smooth magnetic bracket. Finally, secure with a nut.

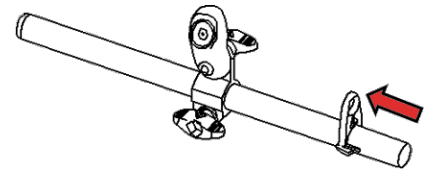

3.d - Slide the other butterfly screw through the T-notched connection on the none-logo side.

Secure with the nut previously installed in 3.b.

3.e - Put the previously assembled part through the longest tube.

- If you aim with the right eye, the magnet must be facing left side.
- If you aim with the left eye, the magnet must be facing right side.

3.f - Put the wedge on the ring and slide them through the stock of the tube.

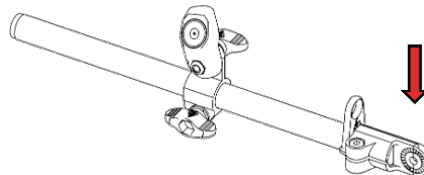
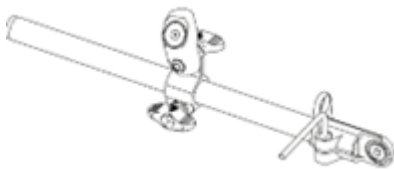

3.g - Put the connection with internal notches on the tube and screw it with the Hex key.

3.h - Apply some oil around the internal notches.

3.i - Place one O'ring and the nut on the internal notched connector.

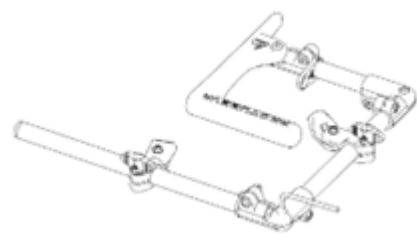
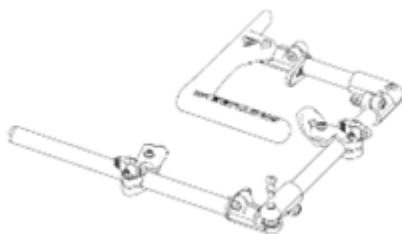

3.j - Place one O'ring on the 18mm screw previously removed from the T-notched connector (step 3.b).

Slide them both through the external notched connection and the internal connection.

Secure it with the nut on the other side.

3.k - Screw all the pieces together taking care to not over tighten. You must be still able to rotate the two parts by force.

STEP 4: ADJUSTMENTS

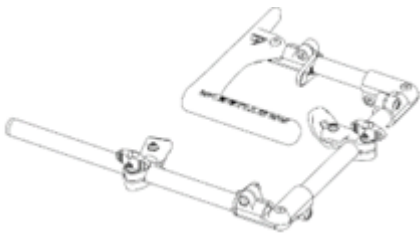

4.a - Bend all the connections at an angle of 90° so that the MagTube Rifle almost forms a square.



4.b - Adjust the medium tube with the top of the stock and tighten a bit more the screw from step 1.b.

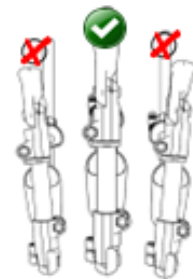

4.c - Adjust the long tube with the rear of the butt and tighten a bit more the screw from step 2.j.

STEP 5: FINAL TOUCH

You can magnetically attach the cups to the black magnetic holders.

Make sure the logo on the cups are facing the front of the Rifle.

Now, you can remove the wrist straps of your controllers and replace them with the ProTubeVR ones.

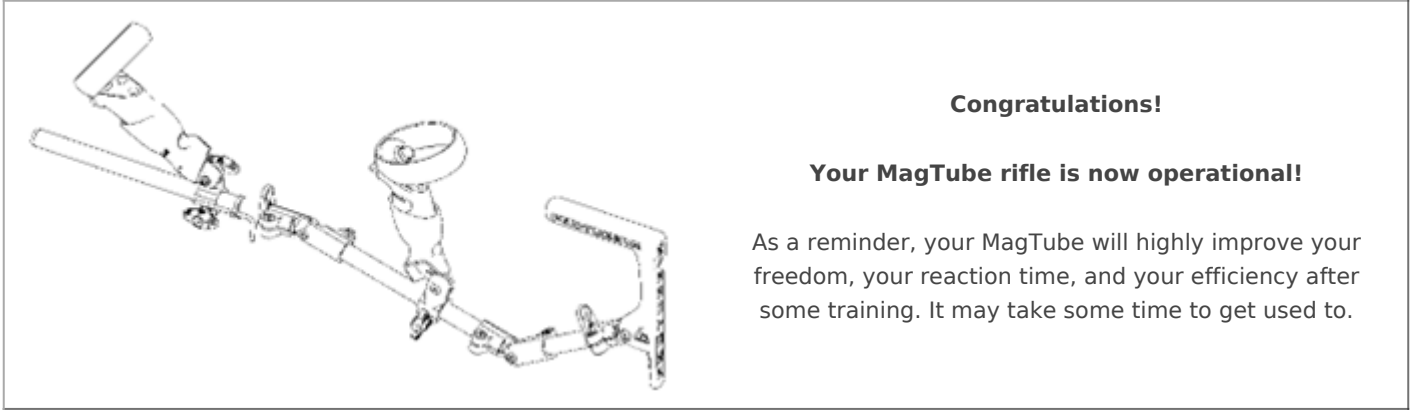

Congratulations!

Your MagTube rifle is now operational!

As a reminder, your MagTube will highly improve your freedom, your reaction time, and your efficiency after some training. It may take some time to get used to.

Revision #7
Created 24 April 2025 12:09:46 by jon
Updated 30 October 2025 15:15:13 by Sephooth